

DENON[®]

DA-10

Portable USB-DAC/
Headphones Amplifier

Owner's Manual

You can print more than one page of a PDF onto a single sheet of paper.

[Front panel](#)[Side panel](#)[Rear panel](#)[Index](#)

Accessories	5
Main features	6
High quality sound	6
High performance	6
Part names and functions	7
Front panel	7
Side panel	8
Rear panel	9
Charging for the first time	10

Connections

Connecting a headphone	13
Connecting a PC or Mac	14
Connecting an iPod to the iPod/iPhone port	15
Connecting a smartphone or portable player	17
Connecting an amplifier	18
Storing in the Pouch	19



Playback

Basic operation	21
Turning the power on	21
Selecting the input source	22
Adjusting the volume	22
Using as a D/A converter	23
Connecting and playing back from a computer (USB-DAC)	24
Playing back an iPod	32
Playing an iPod	33
Playing audio from devices connected to the AUX connector	34

Settings

Setting list	35
---------------------	-----------

Tips

Contents	37
Troubleshooting	38



Appendix

D/A converter	41
Explanation of terms	42
Trademark information	43
Specifications	44
Index	47



Thank you for purchasing this Denon product.

To ensure proper operation, please read this owner's manual carefully before using the product.

After reading this manual, be sure to keep it for future reference.

Accessories

Check that the following parts are supplied with the product.

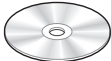
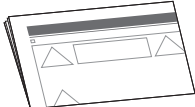
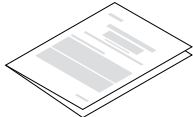
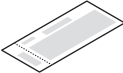
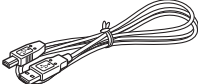
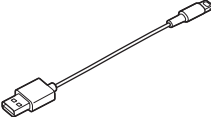
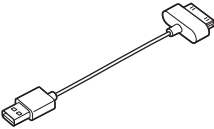
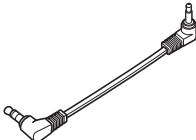
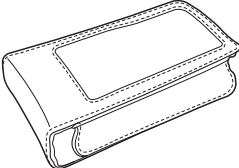
 <p>Quick Start Guide</p>	 <p>Owner's Manual (CD-ROM)</p>	 <p>Safety Instructions</p>	 <p>Warranty (North America model only)</p>
 <p>Warranty (China model only)</p>	 <p>Micro USB cable (Micro B)</p>	 <p>Lightning USB cable</p>	 <p>30pin USB cable</p>
 <p>Stereo mini plug cable</p>	 <p>Pouch</p>		



Main features

High quality sound

- **Advanced AL32 Processing and high precision 32 bit D/A converter**

Equipped with Advanced AL32 Processing, Denon's unique analog wave reproduction technology. Reproducibility of weak signals is increased by expanding the 16-bit digital data to 32 bits. Additionally, the unit is equipped with a 192 kHz/32-bit compatible high performance D/A converter for converting the digital data expanded by Advanced AL32 Processing into analog signals.

- **High sound quality operational amplifier + current buffer**

The unit is equipped with a low noise, high sound quality operational amplifier.
The output level features a discrete current buffer circuit for fully driving the headphones.

- **Low phase noise crystal**

Two low phase noise crystals (22.5792 MHz, 24.576 MHz) are used for the master clock.
The crystals remove jitter from the master clock and faithfully reproduce the high resolution sound source by syncing with and switching the sampling frequency.

High performance

- **Equipped with a USB-DAC function to support playback of high-resolution sound sources**

This unit supports the playback of high resolution audio formats such as DSD (2.8/5.6 MHz) and PCM files up to 192 kHz/24 bits. It provides high quality playback of high resolution files.

- **GAIN switch**

Switching the gain enables optimum driving of various types of headphones that have different impedances.



Part names and functions

For buttons not explained here, see the page indicated in parentheses ().

Front panel

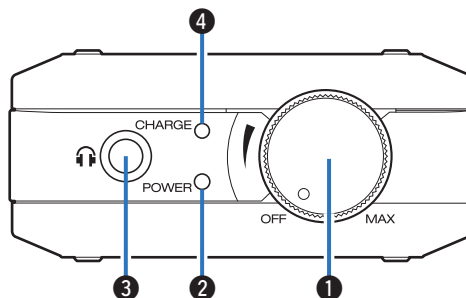

① Power/Volume knob

- This turns the power on/off. (☞ p. 21)
- This adjusts the volume level. (☞ p. 22)

② Power indicator (POWER)

The standby indicator changes as shown below according to the status of the unit.

- Power on : Green
- Power off : Off

③ Headphones jack

Used to connect headphones.

NOTE

To prevent hearing loss, do not raise the volume level excessively when using headphones.

④ Battery indicator (CHARGE)

This displays the amount of remaining battery and charge status. (☞ p. 11)



Side panel

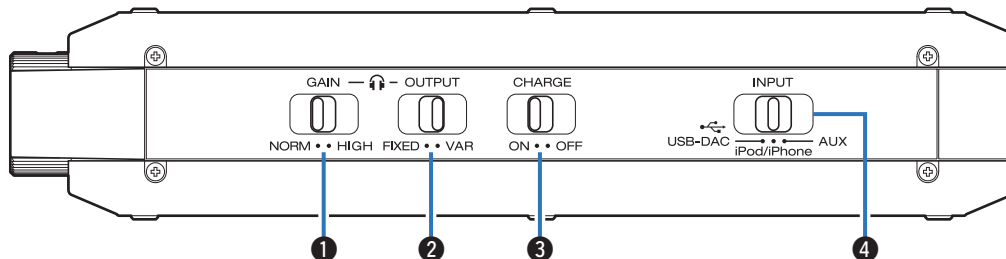

1 Gain selecting switch (GAIN)

This switches the headphone output gain. (☞ p. 35)

2 Output mode selecting switch (OUTPUT)

Set the output mode according to the device to be connected.
(☞ p. 36)

3 Charge mode selecting switch (CHARGE)

Switches the charge mode when the power is on. (☞ p. 36)

4 Input source selecting switch (INPUT)

This switches the source being played back on the unit. (☞ p. 22)



Rear panel

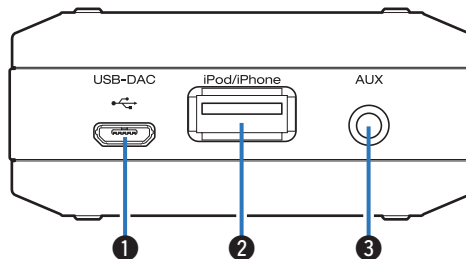

1 USB-DAC port

Connects to a computer or USB charger. (🔗 p. 10, 14)

2 iPod/iPhone port

Connects to an iPod/iPhone/iPad. (🔗 p. 15)

3 AUX input connector

Connect this to the headphones jack on a smartphone or portable player. (🔗 p. 17)



Charging for the first time

This unit has an internal battery. Be sure to charge the battery before use.

It takes approximately 3.5 hours to recharge the battery when it is completely run down using a USB charger (1.5 A or higher) or approximately 6.5 hours when charging from a computer.

1 Turn the power off.

- This unit can be charged when the power is on, but doing so increases the time required for charging.

2 Use the supplied micro USB cable to connect this device to a computer, or connect a USB charger to the USB-DAC port.

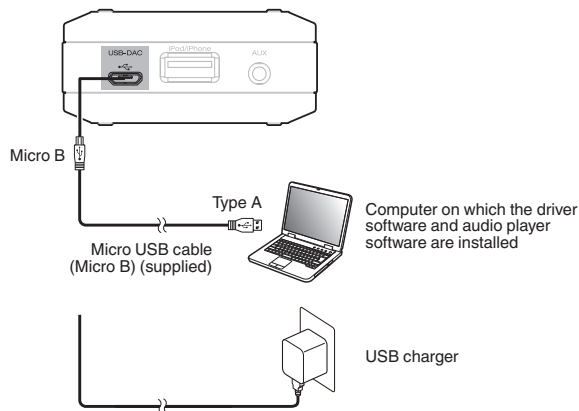

NOTE

- Before USB connecting this unit to your computer, install the driver software in your computer. (☞ p. 24)
- Download the driver software from the DA-10 page of the Denon website.
- It may take some time for this unit to be recognized as an enabled device on the computer the first time it is connected to a computer.
- Charge this unit in a location where the ambient temperature is between 5 to 35 °C. The unit may not charge if the temperature is outside this range.
- Connect this unit directly to a computer. It may not charge correctly if connected through a USB hub, etc.
- If you are listening to music at high volume while charging this unit, the battery may still run down even while charging the unit if the speed at which power is consumed is faster than the charging speed.
- Do not charge this unit while it is inside the supplied pouch, as doing so will cause heat to build up. Remove this unit from the pouch before charging.
- Remove this unit from the charger when charging is complete.
- Charge this unit approximately once every six months, even if you do not use it for a long time.
- Do not connect this unit to a device with a charging voltage other than 5V.
- If you connect this unit to a computer, make sure that the power of the computer is on.



■ Battery indicator

Battery indicator (CHARGE)

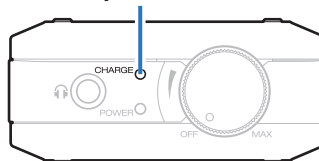

The status of the battery when charging this unit or when using this unit are displayed as described below.

① When connected using the micro USB cable (charging)

Fully charged: Lit green

Charging: Lit orange

Charging stopped: Off

Not charging correctly: Lit red

- If the battery indicator is lit in red during charging, it is recommended that you change the battery.
Contact our customer service center or repair center.

② When running on the battery

The remaining battery power is displayed for approximately 10 seconds when the power is turned on.

Remaining battery	Battery indicator (CHARGE)
50 - 100 %	Blinking green (5 times when the power is turned on)
20 - 49 %	Blinking orange (5 times when the power is turned on)
19 % or less	Blinking red (continuous)







■ Contents

Connecting a headphone	13
Connecting a PC or Mac	14
Connecting an iPod to the iPod/iPhone port	15
Connecting a smartphone or portable player	17
Connecting an amplifier	18
Storing in the Pouch	19

■ Cables used for connections

Provide necessary cables according to the devices you want to connect.

Micro USB cable (Micro B) (supplied)	
Lightning USB cable (supplied)	
30 pin USB cable (supplied)	
Stereo mini plug cable (supplied)	
Audio cables (sold separately)	



Connecting a headphone

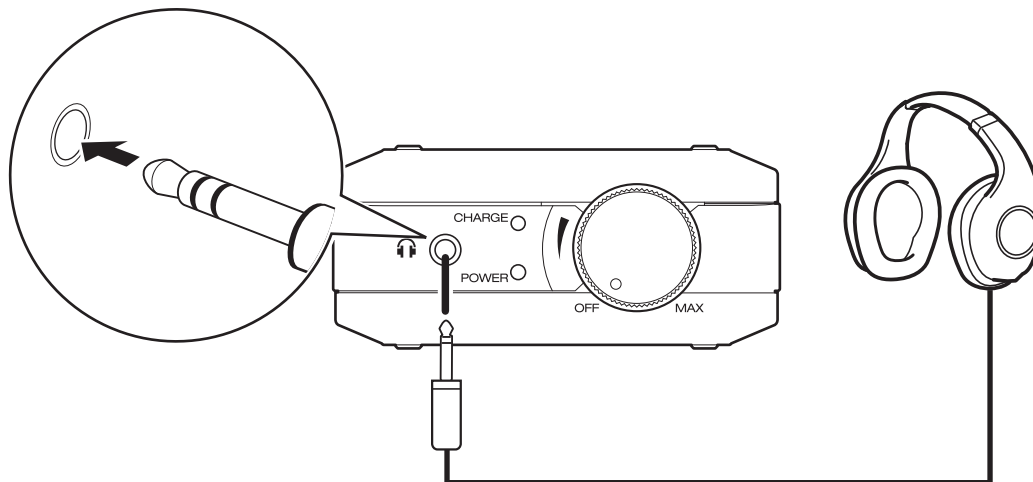

- 1 Set the output mode selecting switch to “VAR”.

NOTE

Audio is output at a high volume from the headphones jack if the output mode selection switch is set to “FIXED”. (☞ p. 36)



Connecting a PC or Mac

By connecting a computer to the USB-DAC port on this unit using a micro USB cable (supplied), music data stored on the computer can be played back using this unit. (🔗 p. 24)

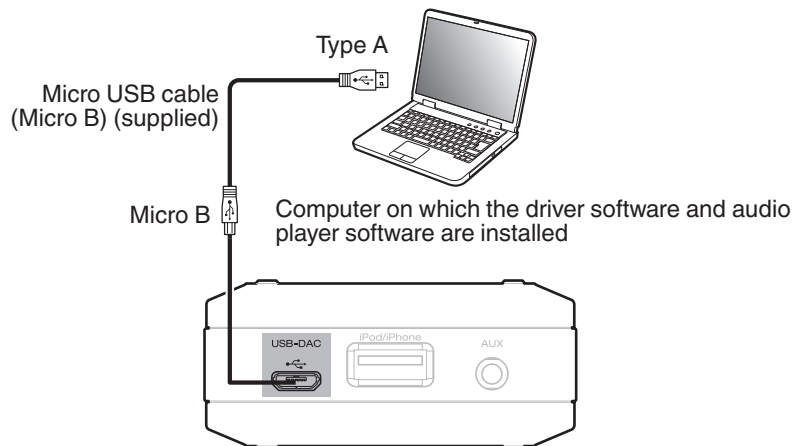

- Before USB connecting this unit to your computer, install the driver software in your computer. (🔗 p. 24)
- Download the driver software from the DA-10 page of the Denon website.

NOTE

Use the supplied cable or a 3 m or less cable to connect to a computer.



Connecting an iPod to the iPod/iPhone port

You can enjoy music stored on an iPod.

- To connect an iPod/iPhone/iPad to this unit, use the USB cable that was supplied with the iPod/iPhone/iPad or the USB cable supplied with this unit.
- For operating instructions, see “Playing an iPod” (🔍 p. 33).
- For information on the iPod models that can be played back with this unit, see “Supported iPod/iPhone/iPad models” (🔍 p. 16).

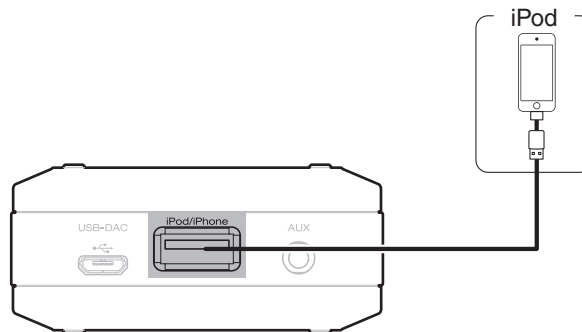

■ Supported iPod/iPhone/iPad models

• iPod classic



iPod classic
120GB (2009)



iPod classic
160GB (2009)

• iPod nano



iPod nano
3rd generation
(video)
4GB 8GB



iPod nano
4th generation
8GB 16GB



iPod nano
5th generation (video camera)
8GB 16GB



iPod nano
6th generation
8GB 16GB



iPod nano
7th generation
16GB

• iPod touch



iPod touch
2nd generation
8GB 16GB 32GB



iPod touch
3rd generation
32GB 64GB



iPod touch
4th generation
8GB 16GB 32GB 64GB



iPod touch
5th generation
16GB 32GB 64GB

• iPhone



iPhone 3GS
8GB 16GB 32GB



iPhone 4
8GB 16GB 32GB



iPhone 4S
16GB 32GB 64GB



iPhone 5
iPhone 5c iPhone 5s
16GB 32GB 64GB

• iPad

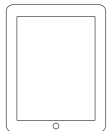

iPad
16GB 32GB 64GB

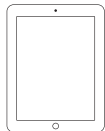

iPad 2
16GB 32GB 64GB

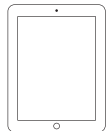

iPad
3rd generation
16GB 32GB 64GB

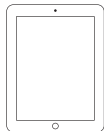

iPad
4th generation
16GB 32GB 64GB 128GB



iPad mini
1st generation
16GB 32GB 64GB



iPad mini
2nd generation
16GB 32GB 64GB 128GB



Connecting a smartphone or portable player

By connecting the stereo mini plug cable (supplied) to the AUX input connector of this unit and the audio output connector of a smartphone or portable player, you can enjoy audio from the connected device.

- For operating instructions, see “Playing audio from devices connected to the AUX connector” (👉 p. 34).

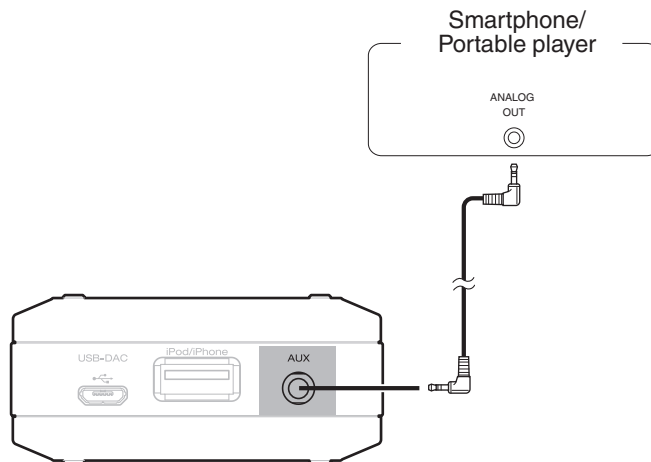

Connecting an amplifier

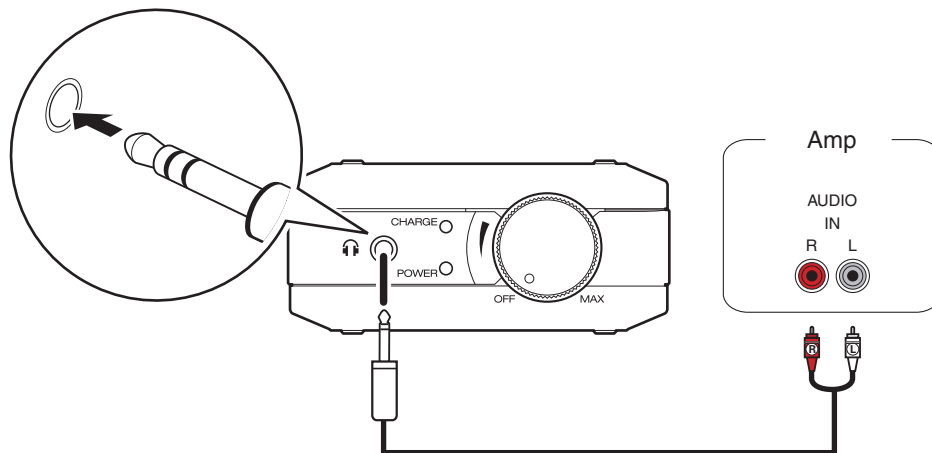

- 1 Set the output mode selecting switch to “FIXED”. (📖 p. 36)

NOTE

An amplifier or speaker(s) must be connected to play back music. For details on connections, see your device's manual.



Storing in the Pouch

■ Storing/Holding

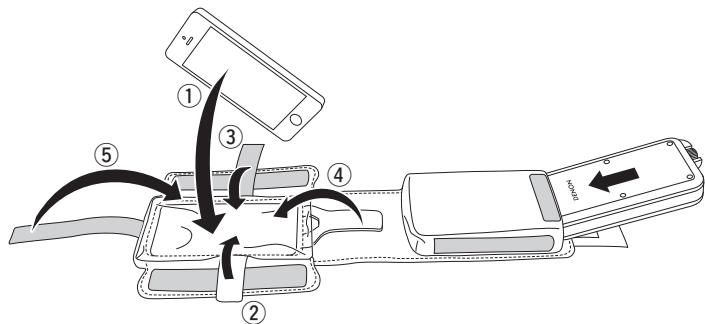

■ Connecting

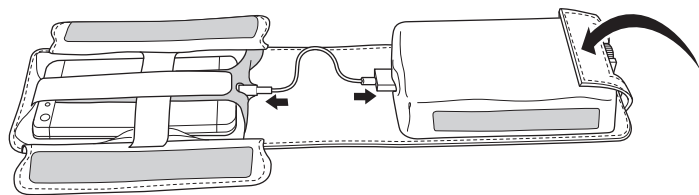

■ Folding

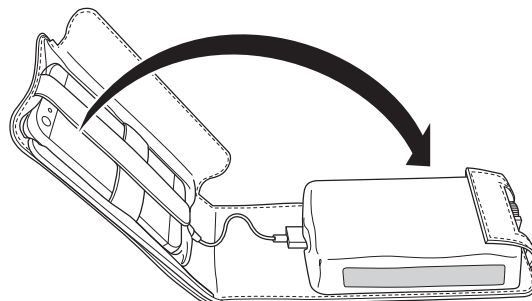

■ Complete

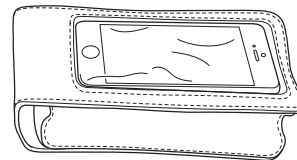

■ Contents

Turning the power on	21	Using as a D/A converter (USB-DAC)	23
Selecting the input source	22	Playing an iPod	32
Adjusting the volume	22	Playing audio from devices connected to the AUX connector	34



Basic operation

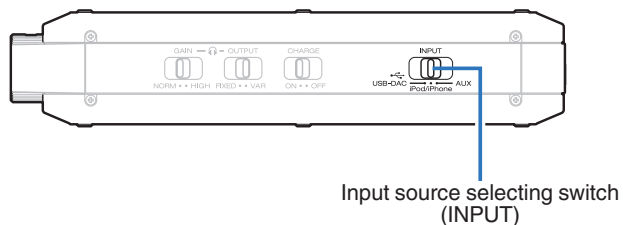
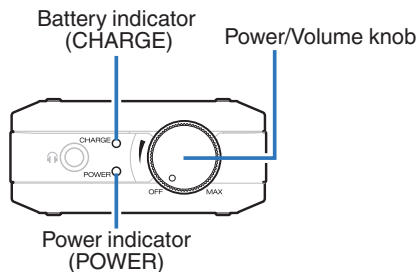

Turning the power on

1 Turn the Power/Volume knob to the right to switch on the power.

The power indicator (POWER) lights.

- When running on the battery, the battery indicator (CHARGE) blinks and displays the remaining battery power. (☞ p. 11)

■ Turning the power off

1 Turn the Power/Volume knob to the left until a “click” is heard.

The power turns off and the power indicator (POWER) turns off.

NOTE

The battery runs down if the power is left on.
Be sure to turn the power off when not using this unit.



Selecting the input source

- 1 Select the playback source using the input source switch (INPUT).

USB-DAC:	Plays back audio files on the computer.
iPod/iPhone:	Plays back the iPod.
AUX:	Plays back analog audio signals input to the AUX connector.

Adjusting the volume

- 1 Turn the Power/Volume knob to adjust the volume.



Using as a D/A converter

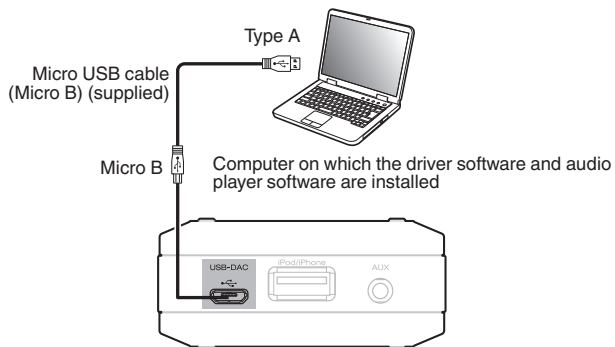

Digital audio signals input from a computer into this unit can be converted and output as analog signals using this unit's D/A converter. (D/A converter function)

- **DSD is a registered trademark.**
- **Microsoft, Windows Vista, Windows 7 and Windows 8 are either registered trademarks or trademarks of Microsoft Corporation in the United States and/or other countries.**
- **Apple, Macintosh and Mac OS are trademarks of Apple Inc., registered in the U.S. and other countries.**



Connecting and playing back from a computer (USB-DAC)

You can enjoy high-quality audio playback from the D/A converter built in to this unit by inputting PCM signal or DSD signal music files into this unit from a computer via USB connection.

- Before USB connecting this unit to your computer, install the driver software in your computer.
- Drivers do not need to be installed for Mac OS.
- Also, you can use whichever commercially available or downloadable player software you like to playback files on your computer.

■ Computer (recommended system)

OS

- Windows® Vista, Windows 7 or Windows 8/8.1
- Mac OS X 10.6.3 or later

USB

- USB 2.0: USB High speed/USB Audio Class Ver.2.0

Windows OS Installing the dedicated driver (🔗 p. 24)

Mac OS Audio Device Settings (🔗 p. 30)

■ Installing the dedicated driver (Windows OS only)

□ Installing the driver software

- 1 Disconnect the USB cable between your PC and the unit.**
 - The driver software cannot be installed correctly if your PC is connected to the unit by a USB cable.
 - If the unit and your computer are connected by a USB cable and the computer is switched on before installation, disconnect the USB and restart the computer.
- 2 Download the dedicated driver from the “Download” section of the DA-10 page of the Denon website onto your PC.**
- 3 Unzip the downloaded file, select the 32-bit or 64-bit exe file that matches your Windows operating system, and double-click the file.**



4 Install the driver.

- ① Select the language to use for the installation.
- ② Click “OK”.



- ③ The wizard menu is displayed. Click “Next”.



- ④ Read the Software Licensing Agreement, and click “I accept the terms in the license agreement”.
- ⑤ Click “Next”.



- ⑥ Click “Install” on the installation start dialog.

 - The installation starts. Do not perform any operation on the PC until the installation is completed.

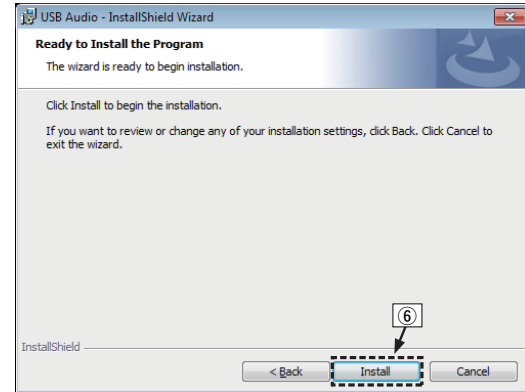

- ⑦ In the Windows security dialog, select “Always trust software from “DandM Holdings Inc.””.
- ⑧ Click “Install”.



- ⑨ When the installation is completed, click “Finish”.

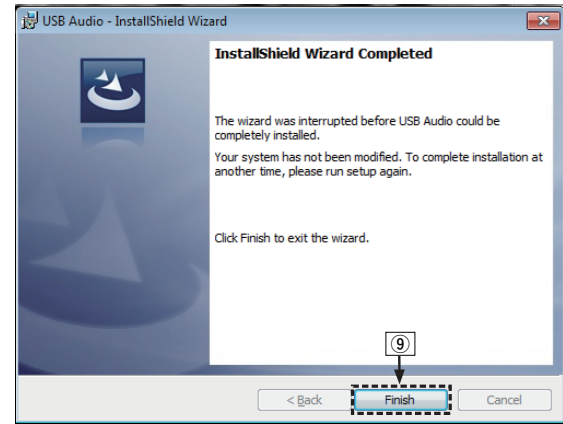

5 With the unit power off, connect the unit and PC using a micro USB cable (supplied).

- For the connection procedure, refer to the “Connecting a PC or Mac” (🔗 p. 14) section.



6 Turn the input source select switch (INPUT) to USB-DAC, and turn on the power of the unit.

- When the unit power is turned on, the PC automatically finds and connects to the unit.

7 Checking the installed driver.

- ① Click the “Start” button and click “Control Panel” on the PC.
 - The control panel setting list is displayed.
- ② Click the “Sound” icon.
 - The sound menu window is displayed.
- ③ Check that there is a checkmark next to “Default Device” under in “Digital Audio Interface” of the “Playback” tab.
 - When there is a checkmark for a different device, click DENON USB Audio and “Set Default”.

8 Checking audio output.

Outputs a TEST signal from the PC and checks the audio output from the USB-DAC function.

- ① Select “Digital Audio Interface” and click “Properties”.
 - The Digital Audio Interface Properties window is displayed.

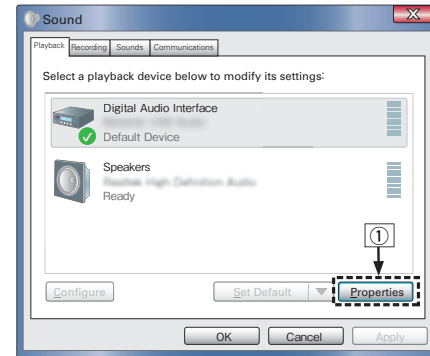

- ② Click the “Advanced” tab.
 - ③ Select the sampling rate and bit rate to be applied to the D/A converter.
 - It is recommended that “2 channel, 24 bit, 192000 Hz (Studio Quality)” is selected.
 - ④ Click “Apply”.
 - ⑤ Click “Test”.
- Check that audio from this unit is output from the PC.

NOTE

- The dedicated driver must be installed in the PC before this unit is connected to a PC. Operation will not occur correctly if connected to the PC before the dedicated driver has been installed.
- Operation may fail in some PC hardware and software configurations.

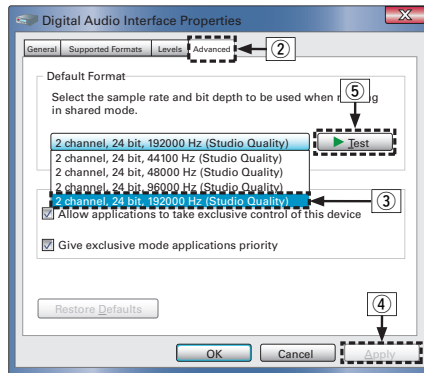

■ Audio Device Settings (Mac OS X only)

- ① Move the cursor to “Go” on the computer screen, and then click “Utilities”.
 - The utility list is displayed.
- ② Double-click “Audio MIDI Setup”.
 - The “Audio Devices” window is displayed.
- ③ Check that “Use this device for sound output” is checked in “DA-10”.
 - If a different device is checked, select and “Secondary click” on “DA-10”, and then select “Use this device for sound output”.

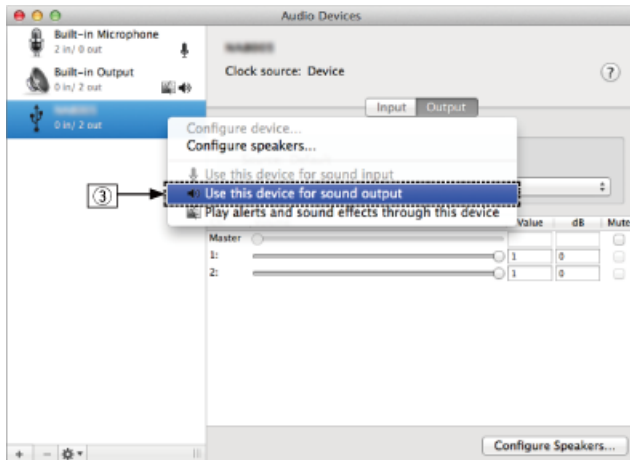

- ④ Select the “DA-10” format.
 - It is normally recommended to set the format to “192000.0 Hz” and “2ch-24 bit Interger”.

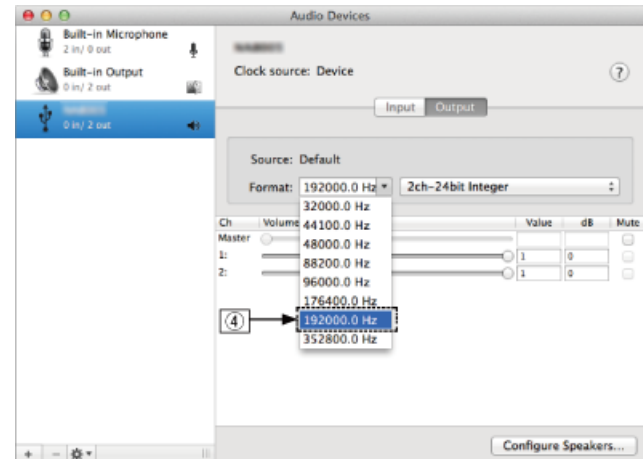

- ⑤ Click “Quit Audio MIDI Setup”.



■ Playback

Install the desired player software on your computer beforehand.
Use the USB-DAC port to connect this unit to a computer. (🔍 p. 14)

1 Turn the input source select switch (INPUT) to USB-DAC.

Start playback on the computer's player software.

■ Files that can be played back

See "D/A converter" (🔍 p. 41).

NOTE

- Perform operations such as playback and pause on the computer.
- You can also control the volume and equalizer on the computer. Enjoy playing music at the desired volume.
- When this unit is functioning as a D/A converter, sound is not output from the computer's speakers.
- If the computer is disconnected from this unit while the computer music playback software is running, the playback software may freeze. Always exit the playback software before disconnecting the computer.
- If an error occurs on the computer, disconnect the micro USB cable and restart the computer.
- Use the supplied cable or a 3 m or less cable to connect to a computer.



Playing back an iPod

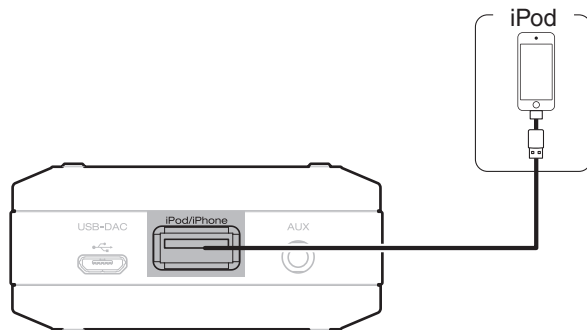

- You can use the USB cable provided with this unit or the USB cable provided with the iPod to connect the iPod with the unit's iPod/iPhone port and enjoy music stored on the iPod.
- For information on the iPod models that can be played back with this unit, see “Supported iPod/iPhone/iPad models” (📖 p. 16).



Playing an iPod

- 1** Turn the input source select switch (INPUT) to iPod/iPhone.
- 2** Connect the iPod to the USB port.
- 3** Operate iPod itself directly while seeing the iPod screen to play back music.

NOTE

- Denon will accept no responsibility whatsoever for any loss of iPod data.
- The iPod cannot be charged by connecting to this unit.



Playing audio from devices connected to the AUX connector

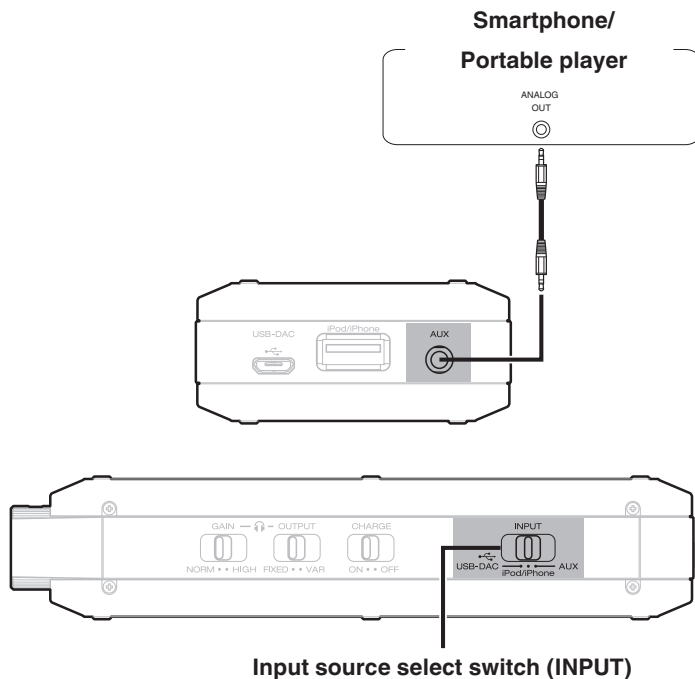

You can connect a smartphone or portable player to the AUX connector of this unit and play back audio.

- 1** Turn the input source select switch (INPUT) to AUX.
- 2** Connect a smartphone or portable player to the AUX connector of this unit. (☞ p. 17)
- 3** Play the component connected to this unit.



Setting list

By default, this unit has recommended settings defined. You can customize this unit based on your existing system and your preferences.

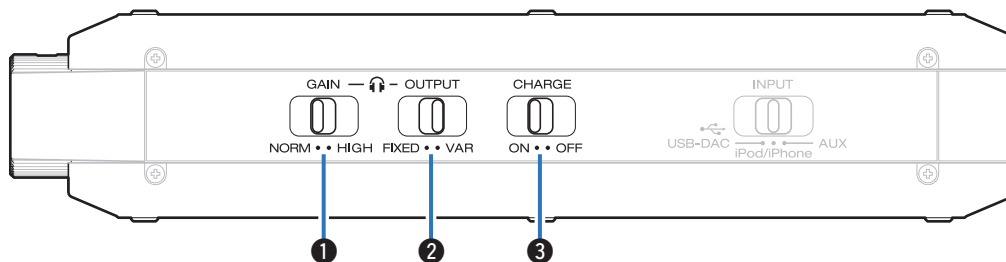

1 Gain selecting switch (GAIN)

This switches the headphone amplifier gain. Set this according to the connected headphones. It is recommended that you first listen using “NORM”, and then switch to “HIGH” if the volume is too low.

NORM (Default):	Set the gain of the headphone amplifier to “NORM”.
HIGH:	Set the gain of the headphone amplifier to “HIGH”.

NOTE

- If the output mode selection switch (OUTPUT) is set to “FIXED”, the gain setting will be “NORM” even if the gain selection switch (GAIN) is “HIGH”.
- The headphone volume varies depending on the gain setting. Decrease the volume the audio first if changing this setting while listening to audio.



2 Output mode selecting switch (OUTPUT)

Set the output mode according to the device to be connected.

FIXED:

This fixes the volume level output from the headphones jack.
Set when connected to an external amplifier or active speaker.

**VAR
(Default):**

The volume level output from the headphones jack can be adjusted.
Set when listening using headphones.

NOTE

- This setting is not enabled even when the output mode selection switch (OUTPUT) is switched when the power is turned on. Turn the unit's power on and off again to enable this setting.
- When "FIXED" is set, audio is output from the headphones jack, but the volume level is the maximum level and cannot be adjusted. When "FIXED" is set, do not connect headphones to this unit.

3 Charge mode selecting switch (CHARGE)

Switches the charge mode when the power is on.

**ON
(Default):**

This unit charges when it is connected to a computer or USB charger. It charges when the power is on or off.

OFF:

To prevent noise caused by charging, this unit is not charged when the power is on, even if this unit is connected to a computer or USB charger. This unit is charged when the power is off, whether the status is CHARGE ON or CHARGE OFF.



Contents

■ Troubleshooting

Power does not turn on / Power is turned off	38
This unit becomes unusually hot or an unusual smell occurs during use	38
Sound is not output/quiet	39
Sound is distorted/sound is interrupted	39
Volume control does not work	40
Cannot charge the unit/charging takes a long time	40



Troubleshooting

1. Are the connections correct?
2. Is the set being operated as described in the owner's manual?
3. Are the other devices operating properly?

If this unit does not operate properly, check the items listed in the table below.

Should the problem persist, there may be a malfunction. In this case, disconnect the power immediately and contact your store of purchase.

■ Power does not turn on / Power is turned off

Symptom	Cause / Solution	Page
Power is not turned on.	<ul style="list-style-type: none"> • The battery is completely exhausted. Charge the unit. 	10
The power turns off quickly.	<ul style="list-style-type: none"> • If the continuous battery usage time has deteriorated to approximately half of the usage time when purchased, it is possible that the battery has reached the end of its life span. Contact the store where you purchased this unit or the customer service center for a replacement battery. 	—

■ This unit becomes unusually hot or an unusual smell occurs during use

Symptom	Cause / Solution	Page
This unit becomes unusually hot or an unusual smell occurs during use.	<ul style="list-style-type: none"> • Immediately turn the power off and stop using this unit. Contact our customer service center or repair center. 	—



■ Sound is not output/sound is quiet

Symptom	Cause / Solution	Page
Sound is not output/sound is quiet.	• Check that the proper input source is selected using the input source selection switch (INPUT).	<u>22</u>
	• Check that power to this unit and the connected devices is on.	—
	• Adjust to an appropriate volume level on this unit and the connected devices.	—
	• Check that the cables are properly connected.	—
	• The AUX input connector on this unit supports 3-pole stereo mini plugs. Be sure to use 3-pole stereo mini plug cables.	—
	• If this unit is not recognized by the computer as a USB device, restart the computer.	—
	• Your headphones may not be set with the appropriate gain settings. Switch the gain selection switch (GAIN) of this unit to “HIGH”.	<u>35</u>

■ Sound is distorted, sound is interrupted

Symptom	Cause / Solution	Page
Sound is distorted, sound is interrupted.	• Turn off the equalizer and other such settings on the playback device.	—
	• Sound may be interrupted if the CPU load on the computer is too large. Exit any unnecessary applications on the computer.	—



■ Cannot adjust the volume

Symptom	Cause / Solution	Page
Cannot adjust the volume.	<ul style="list-style-type: none"> Switch the output mode selecting switch (OUTPUT) to "VAR", and turn the power off and on again. 	<u>36</u>

■ Cannot charge the unit/charging takes a long time

Symptom	Cause / Solution	Page
Cannot charge the unit.	<ul style="list-style-type: none"> Charging may stop if the ambient temperature exceeds the range of 5 to 35 °C. Charge this unit in a location where the temperature is between 5 to 35 °C. 	—
	<ul style="list-style-type: none"> This unit cannot be charged when the power is on if the charge mode selection switch (CHARGE) is set to OFF. Turn the power off or set the charge mode selection switch (CHARGE) to ON. 	<u>36</u>
	<ul style="list-style-type: none"> If this unit is connected to a computer, make sure that the power of the computer is on. 	—
Charging takes a long time.	<ul style="list-style-type: none"> It may take a long time to charge the unit if the unit has not been used for a long time. It is recommended that you replace the battery if the unit does not become fully charged even after charging for more than 18 hours. 	—
	<ul style="list-style-type: none"> It takes longer to charge the unit when charging with the power turned on. Charge the unit with the power turned off. 	—
	<ul style="list-style-type: none"> Replace the cable or charger. 	—



D/A converter

■ Specifications of supported files

□ USB-DAC

	Sampling frequency	Bit length
DSD (2-channel)	2.8/5.6 MHz	1 bit
Linear PCM (2-channel)	32/44.1/48/88.2/96/ 176.4/192 kHz	16/24 bits



Explanation of terms

DSD (Direct-Stream Digital)

One of the audio data recording methods, it is the signal aspect used to store audio signals on a super audio CD, and is Δ - Σ modulated digital audio. It is configured of an array of single bit values at a 2.8224MHz sampling rate.

WMA (Windows Media Audio)

This is the audio compression technology developed by Microsoft Corporation.

WMA data can be encoded using Windows Media® Player.

To encode WMA files, only use applications authorized by Microsoft Corporation. If you use an unauthorized application, the file may not work properly.

Sampling frequency

Sampling involves taking a reading of a sound wave (analog signal) at regular intervals and expressing the height of the wave at each reading in digitized format (producing a digital signal).

The number of readings taken in one second is called the “sampling frequency”. The larger the value, the closer the reproduced sound is to the original.

Bit rate

This expresses the read amount per 1 second of video/audio data recorded in a disc. A larger number means higher sound quality, but also means a larger file size.

Linear PCM

This is an uncompressed PCM (Pulse Code Modulation) signal. This is the same system used for CD audio but uses 192 kHz, 96 kHz, and 48 kHz sampling frequencies on Blu-ray Disc or DVD and provides higher resolution than CD.



Trademark information



"Made for iPod", "Made for iPhone" and "Made for iPad" mean that an electronic accessory has been designed to connect specifically to iPod, iPhone or iPad, respectively, and has been certified by the developer to meet Apple performance standards.

Apple is not responsible for the operation of this device or its compliance with safety and regulatory standards. Please note that the use of this accessory with iPod, iPhone or iPad, may affect wireless performance. iPad, iPhone, iPod, iPod classic, iPod nano, iPod shuffle and iPod touch are trademarks of Apple Inc., registered in the U.S. and other countries.

- Individual users are permitted to use iPad, iPhone, iPod, iPod classic, iPod nano, iPod shuffle, and iPod touch for private copy and playback of non-copyrighted contents and contents whose copy and playback is permitted by law. Copyright infringement is prohibited by law.



Adobe, the Adobe logo and Reader are either registered trademarks or trademarks of Adobe Systems Incorporated in the United States and/or other countries.



Specifications

■ Audio performance

Channels:	2-channels
Playable frequency range:	2 Hz – 96 kHz
Playable frequency response:	2 Hz – 50 kHz (–3 dB) (DSD mode, PCM sampling frequency: 192 kHz) 2 Hz – 20 kHz (PCM sampling frequency: 44.1 kHz)
Harmonic distortion:	0.003 % (1 kHz, Audible range)
Headphone output:	40 mW + 40 mW (32 Ω/ohms, 1 % distortion) 18 mW + 18 mW (600 Ω/ohms, 1 % distortion)
Supported impedance:	8 Ω/ohms - 600 Ω/ohms



■ General

Maximum Input (AUX):	2 Vrms/22 k Ω /kohms
Operating temperature:	0 °C - 40 °C
Charging temperature:	5°C - 35°C
Power requirement:	DC 3.8 V Lithium-ion battery 3200 mAh
Continuous battery usage time:	Approx. 7 hours (when iPod is connected, 1 mW + 1 mW (32 Ω /ohms) output) Approx. 24 hours (when AUX is connected, 1 mW + 1 mW (32 Ω /ohms) output)
Charging time:	Approx. 3.5 hours (when connected to a 1.5 A or higher USB charger) Approx. 6.5 hours (when connected to a computer)

For the purpose of improvement, the specifications and design are subject to change without notice.



■ Dimensions (Unit : in. (mm))

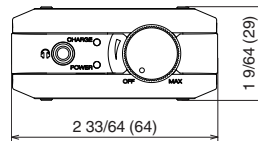
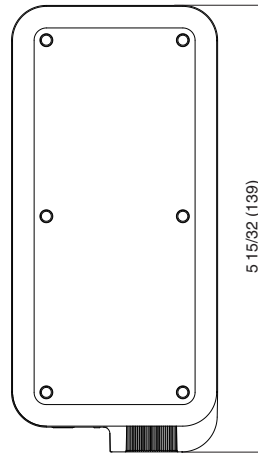

■ Weight : 8.5 oz (0.24 kg)



Index

A	
Accessories	5
Audio cable	12
Audio Device Settings (Mac OS X only)	30
B	
Bit rate	42
C	
Charging	10
Connecting a computer	14
Connecting an amplifier	18
Connecting an iPod	15
D	
D/A converter function	23, 41
DSD	41, 42
I	
Installing the dedicated driver (Windows OS only)	24
P	
Playing back an iPod	32
S	
Sampling frequency	41, 42
Selecting the input source	22
Stereo mini plug cable	12, 17
Storing in the Pouch	19
Supported iPod/iPhone models	16
T	
Turning the power on	21
U	
USB cable	12, 14, 15
USB-DAC	14, 23, 41
W	
WMA	42



DENON®

www.denon.com

D&M Holdings Inc.
3520 10359 00AM